

N,N-ジメチルホルムアミドのマウスを用いた
吸入によるがん原性試験報告書

試験番号 : 0297

FIGURES

FIGURES

- FIGURE 1 *N,N*-DIMETHYLFORMAMIDE VAPOR GENERATION SYSTEM AND INHALATION SYSTEM
- FIGURE 2 SURVIVAL ANIMAL RATE OF MALE MICE IN THE 2-YEAR INHALATION STUDY OF *N,N*-DIMETHYLFORMAMIDE
- FIGURE 3 SURVIVAL ANIMAL RATE OF FEMALE MICE IN THE 2-YEAR INHALATION STUDY OF *N,N*-DIMETHYLFORMAMIDE
- FIGURE 4 BODY WEIGHT CHANGES OF MALE MICE IN THE 2-YEAR INHALATION STUDY OF *N,N*-DIMETHYLFORMAMIDE
- FIGURE 5 BODY WEIGHT CHANGES OF FEMALE MICE IN THE 2-YEAR INHALATION STUDY OF *N,N*-DIMETHYLFORMAMIDE
- FIGURE 6 FOOD CONSUMPTION CHANGES OF MALE MICE IN THE 2-YEAR INHALATION STUDY OF *N,N*-DIMETHYLFORMAMIDE
- FIGURE 7 FOOD CONSUMPTION CHANGES OF FEMALE MICE IN THE 2-YEAR INHALATION STUDY OF *N,N*-DIMETHYLFORMAMIDE

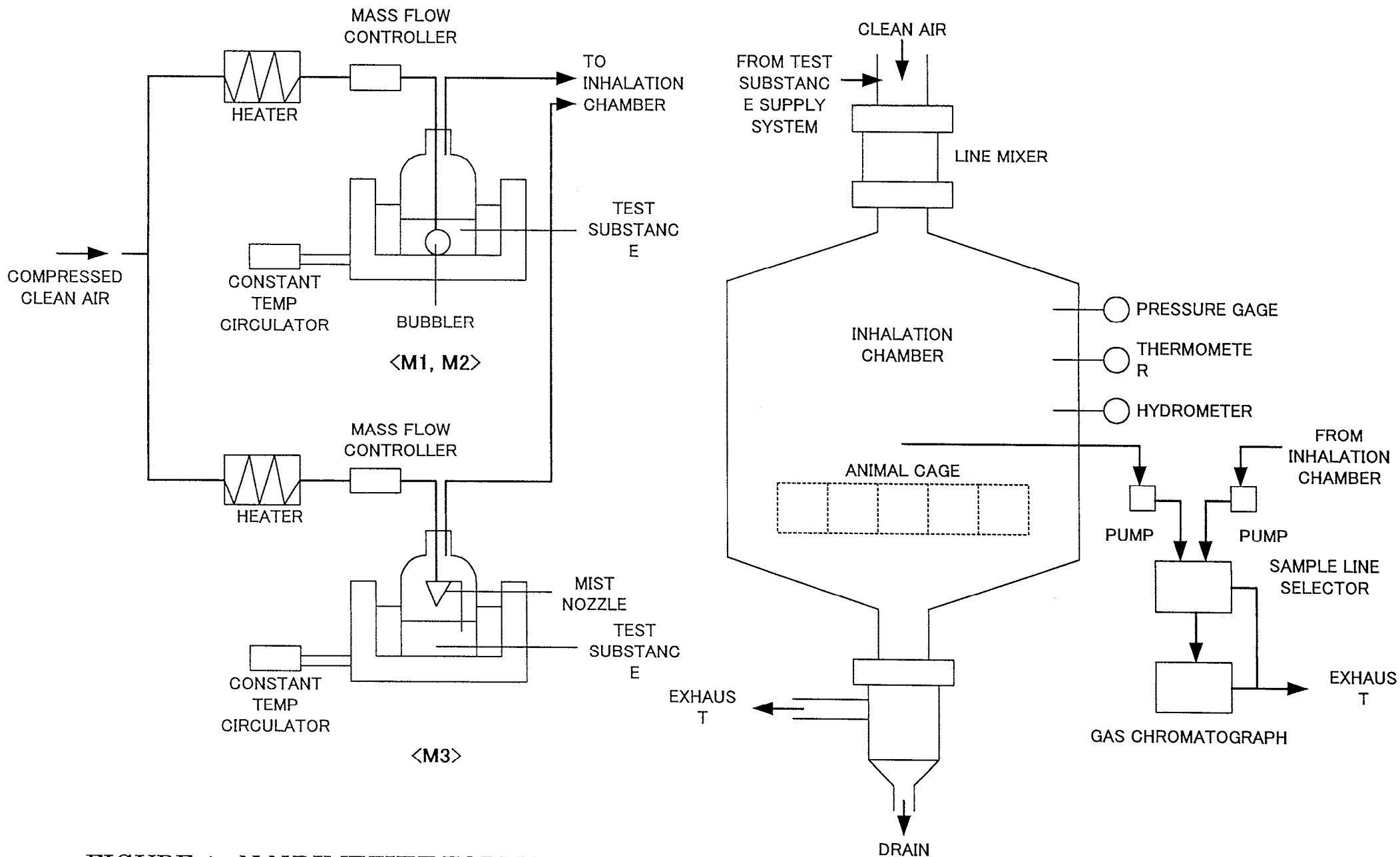

FIGURE 1 *N,N*-DIMETHYLFORMAMIDE VAPOR GENERATION SYSTEM AND INHALATION SYSTEM

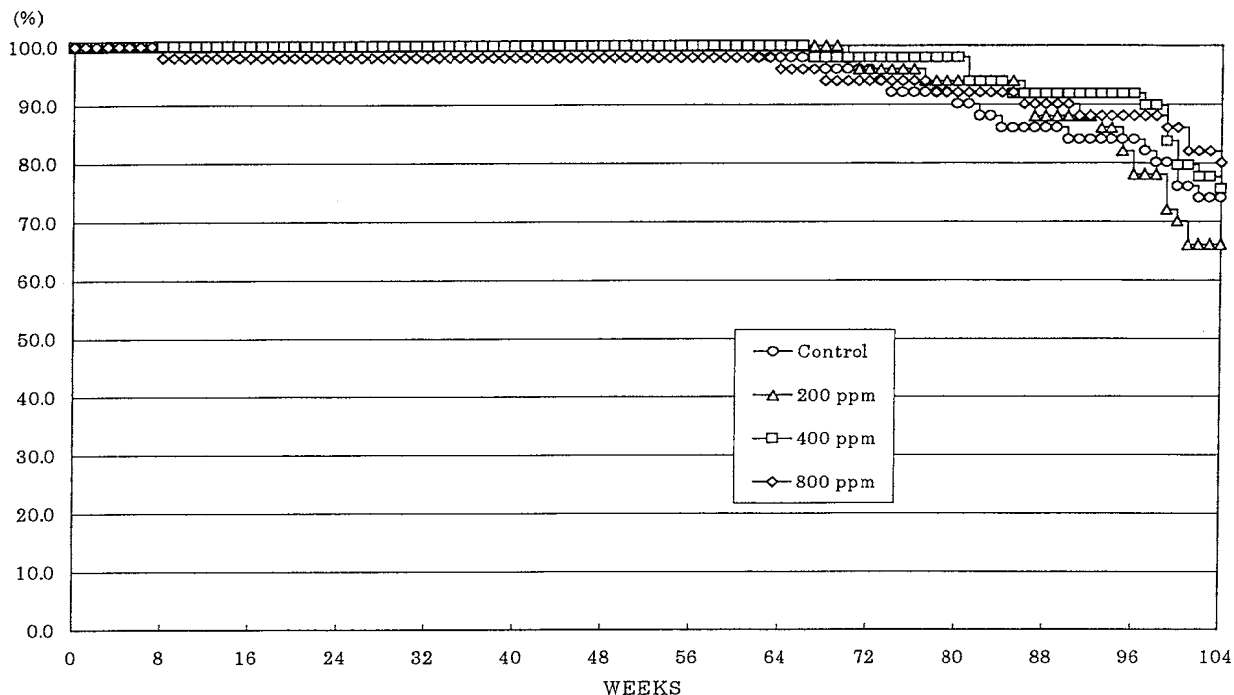

FIGURE 2 SURVIVAL ANIMAL RATE OF MALE MICE IN THE 2-YEAR INHALATION STUDY OF *N,N*-DIMETHYLFORMAMIDE

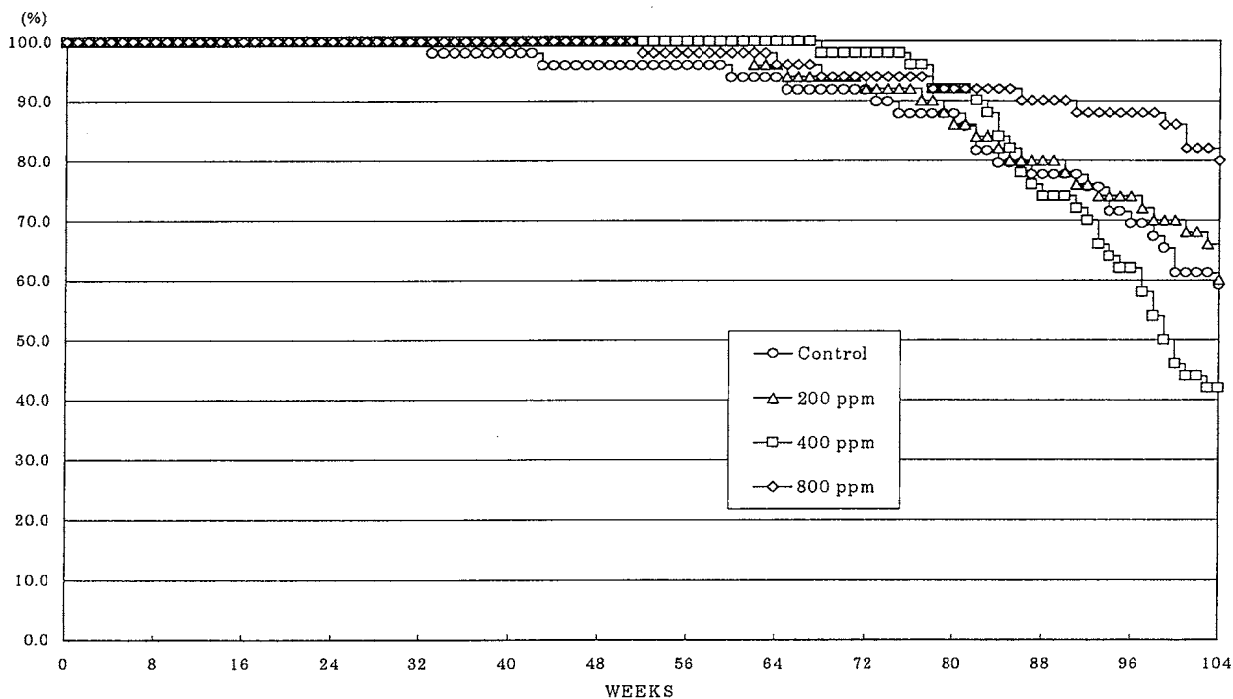

FIGURE 3 SURVIVAL ANIMAL RATE OF FEMALE MICE IN THE 2-YEAR INHALATION STUDY OF *N,N*-DIMETHYLFORMAMIDE

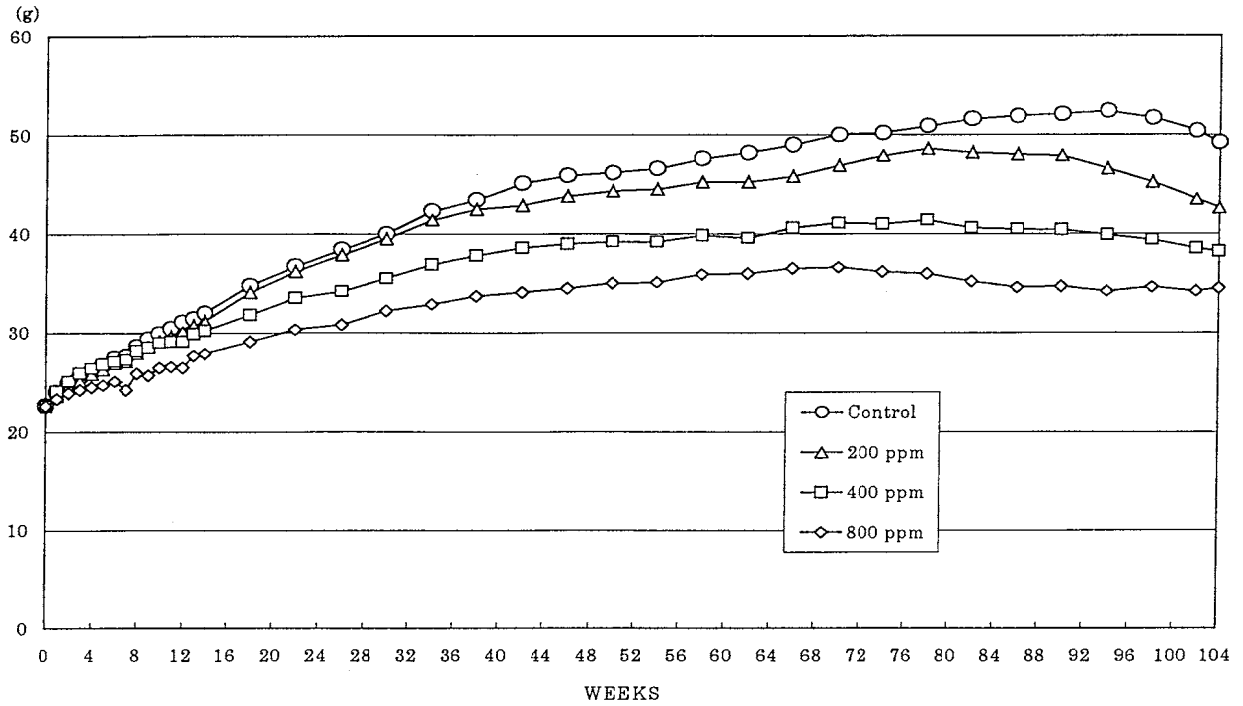

FIGURE 4 BODY WEIGHT CHANGES OF MALE MICE IN THE 2-YEAR INHALATION STUDY OF *N,N*-DIMETHYLFORMAMIDE

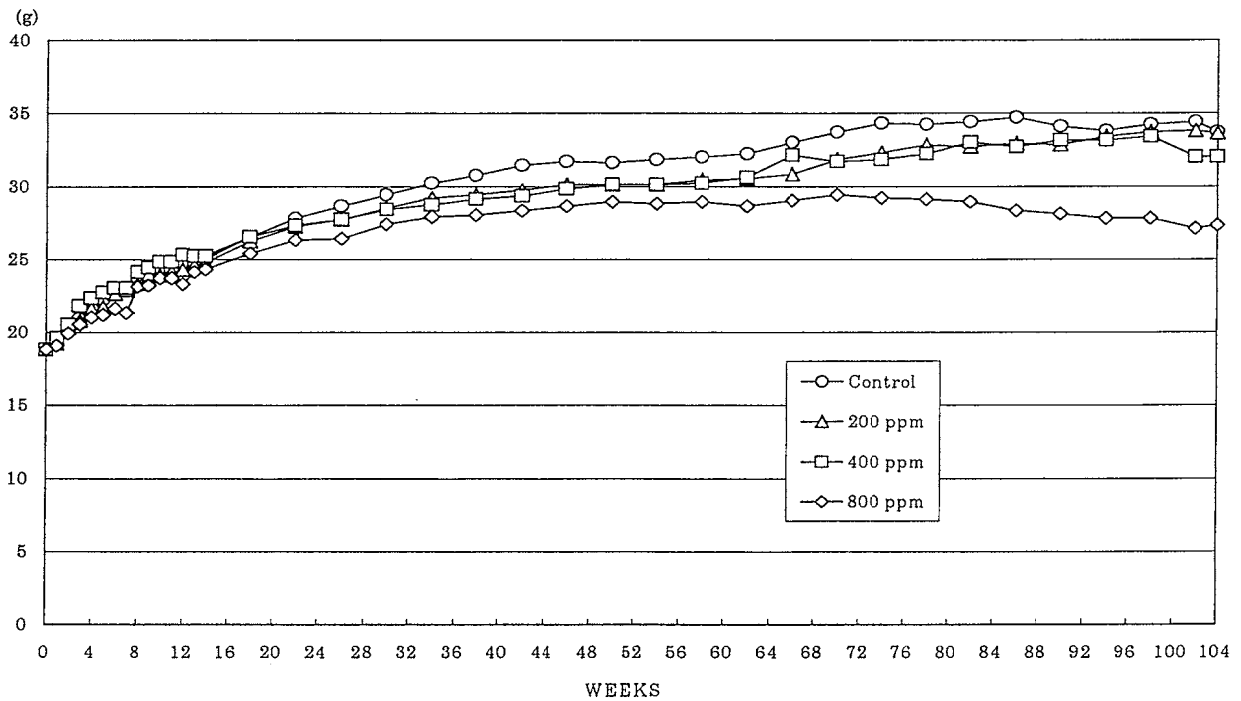

FIGURE 5 BODY WEIGHT CHANGES OF FEMALE MICE IN THE 2-YEAR INHALATION STUDY OF *N,N*-DIMETHYLFORMAMIDE

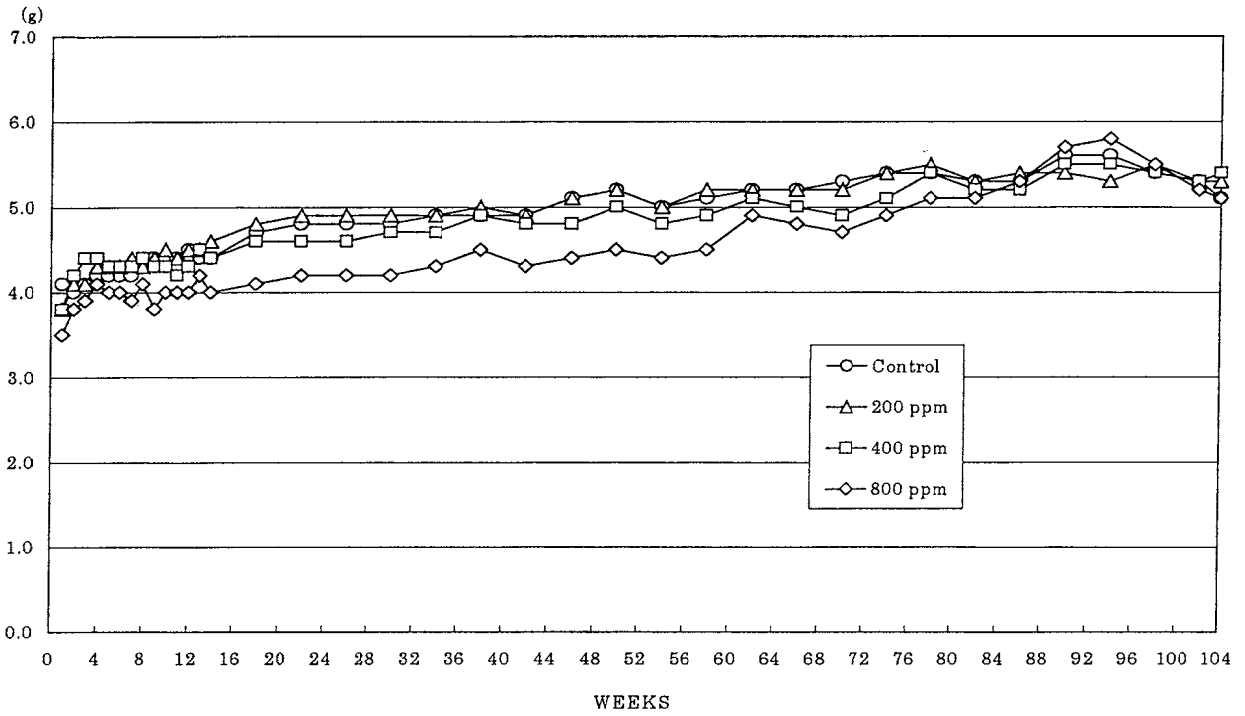

FIGURE 6 FOOD CONSUMPTION CHANGES OF MALE MICE IN THE 2-YEAR INHALATION STUDY OF *N,N*-DIMETHYLFORMAMIDE

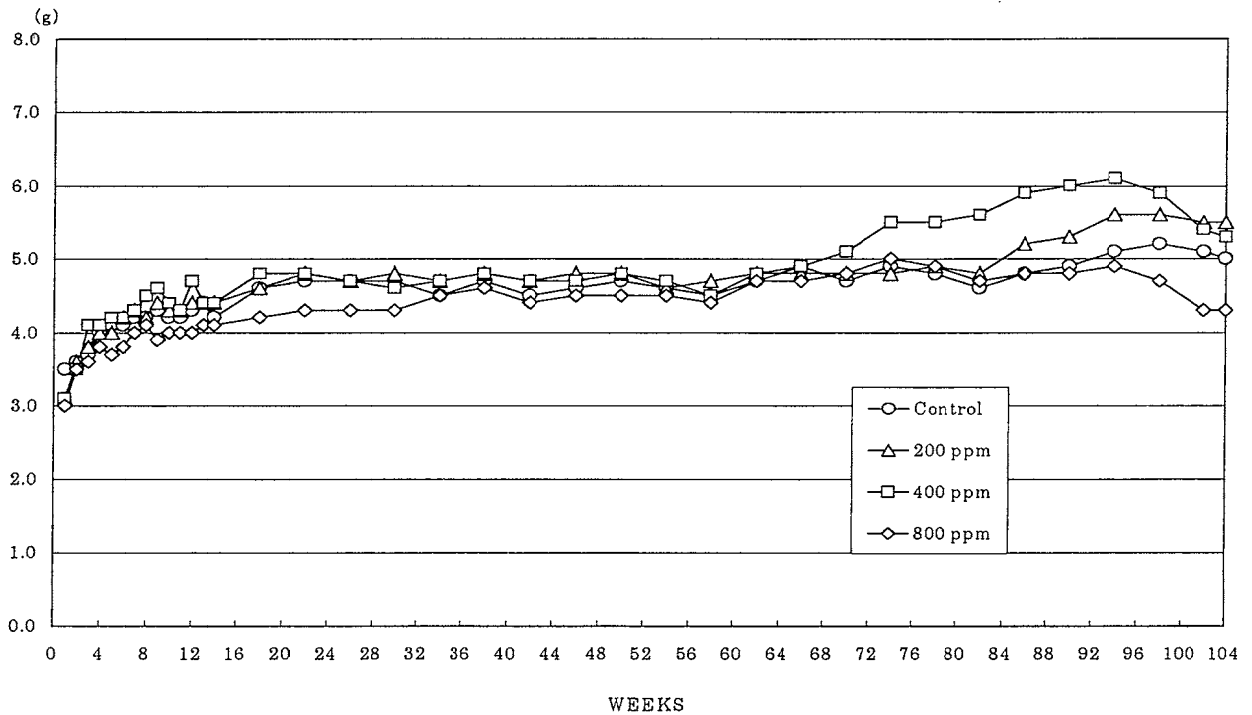

FIGURE 7 FOOD CONSUMPTION CHANGES OF FEMALE MICE IN THE 2-YEAR INHALATION STUDY OF *N,N*-DIMETHYLFORMAMIDE